

VFDC-4000 Controller

Variable Frequency Drive Controller

User Manual



This manual explains the features and operations of the VFDC-4000 controller which is specifically designed for Pressure Booster Pump Systems. The VFDC-4000 controller is capable of maintaining a constant discharge pressure by adjusting the speed of 1 to 4 Variable Frequency Drives (VFDs).

SJE-Rhombus[®]

www.sjerhombus.com

WARNINGS

Failure to read and understand the information provided in this manual may result in personal injury or death, damage to the product or product failure. Please read each section in its entirety and be sure you understand the information provided in the section and related sections before attempting any of the procedures or operations given.

Failure to follow these precautions could result in serious injury or death. Keep these instructions with warranty after installation. This product must be installed in accordance with National Electrical Code, ANSI/NFPA 70 so as to prevent moisture from entering or accumulating within the controller housing.

WARNING

ELECTRICAL SHOCK HAZARD



Disconnect power before installing or servicing this product. A qualified service person must install and service this product according to applicable electrical codes and electrical schematics.

- Do not install in area with: excessive or conductive dust, corrosive or flammable gas, moisture or rain, excessive heat, regular impact shocks or excessive vibration.
- Do not place in water or let water leak onto the controller.
- Do not allow debris to fall inside the unit during installation.
- Double-check all the wiring before turning on the power supply.
- Do not touch live wires.
- Stay as far as possible from high-voltage cables and power equipment.
- Leave a minimum of 10 mm space for ventilation between the top and bottom edges of the controller and enclosure walls.

WARNING

EXPLOSION OR FIRE HAZARD



Do not use this product with flammable liquids. Do not install in hazardous locations as defined by National Electrical Code, ANSI/NFPA 70.

Table of Contents

Chapter 1

1.1 Controller Description	2
1.2 Controller Outline Dimension	3

Chapter 2

2.1 Description of Each Function	4
2.2 Definitions	6
2.3 Default Values	7
2.4 Key & Icon Description	9
2.5 Description of LCD Screen	10

Chapter 3

3.1 Security	11
3.2 Setup Menus	11
3.3 Setup Menu Display & Input Method	14

Chapter 4

4.1 Terminal Connection Connections	16
4.2 Controller Circuit Diagram of Communication Operation	17

Chapter 5

5.1 Troubleshooting	18
---------------------------	----

Chapter 6

6.1 Fault Alarm Display & Corrective Actions	19
6.2 Alarm Data Log	20
6.3 Operation Data Log	20

ModBus Communication Functions & Adress Code	22
---	-----------

Serial Cable for RS232 Communication	24
---	-----------

Chapter 1

1.1 Controller Description

<Front View>

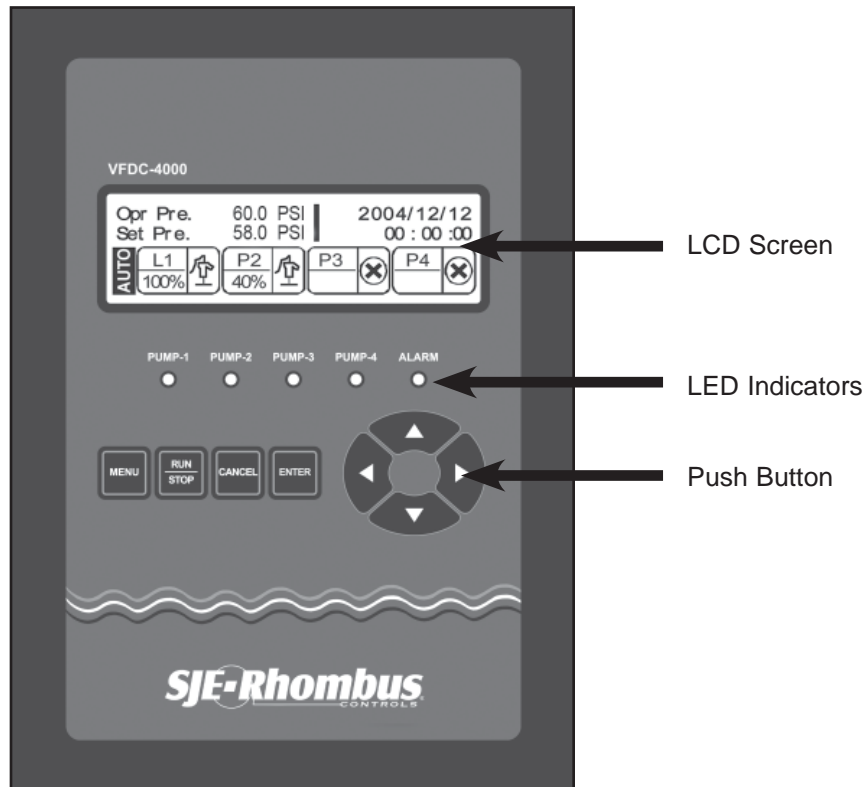

<Rear View>

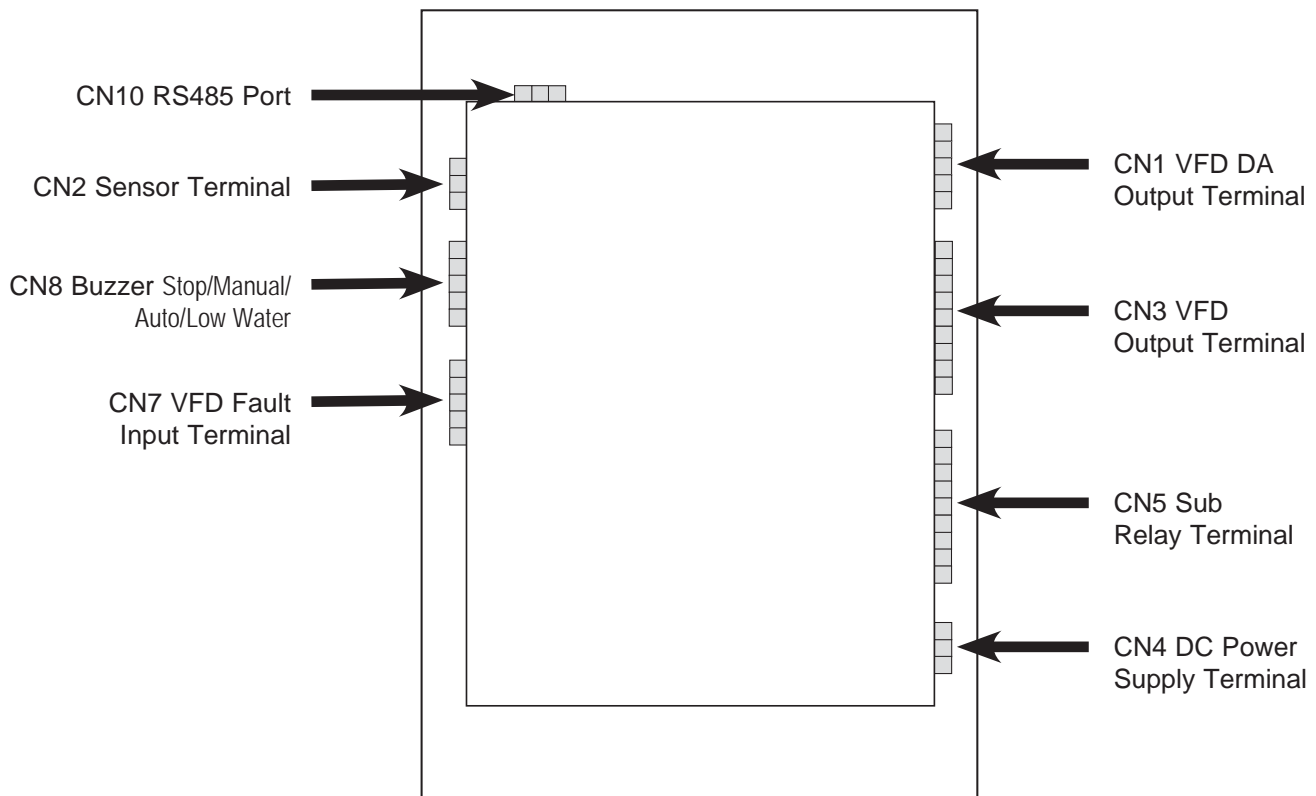

1.2 Controller Outline Dimensions in inches.

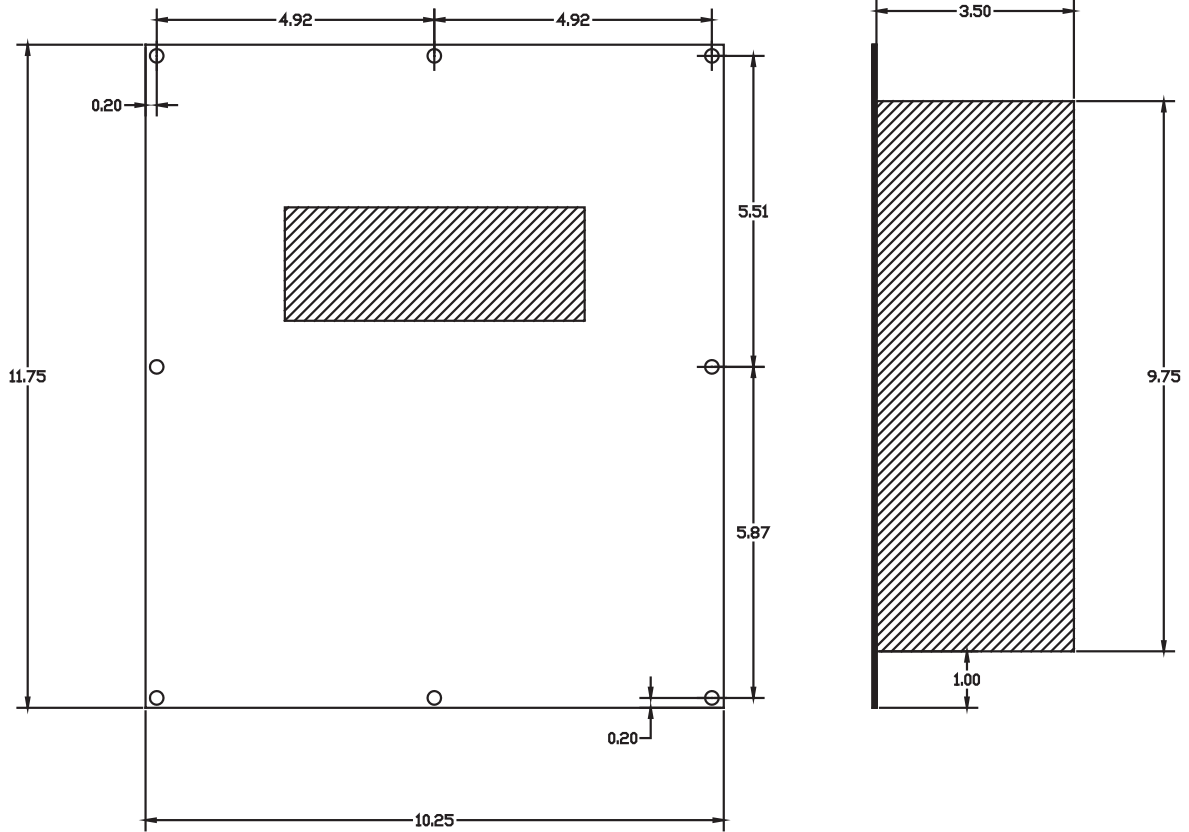

Controller Outline Dimensions (In Inches)

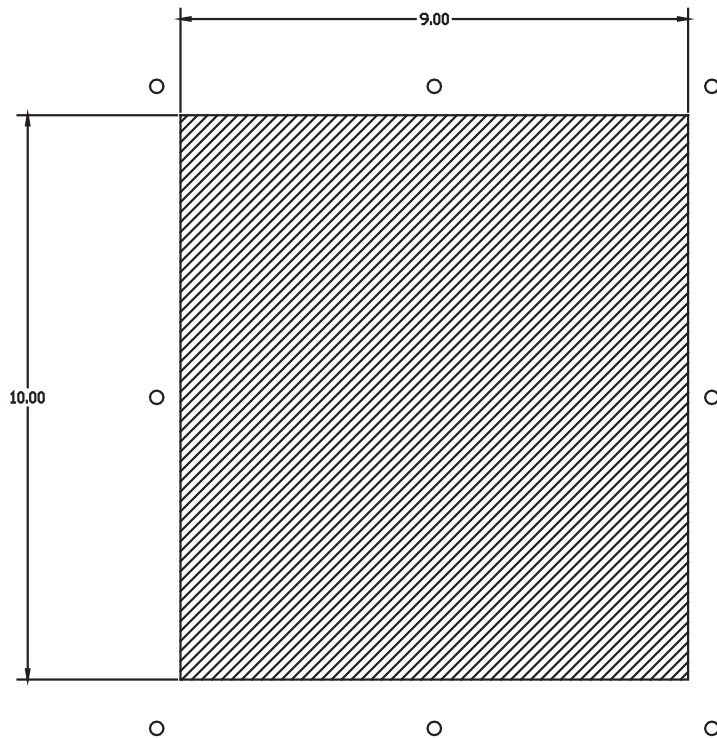

Panel cutout dimensions. (In Inches)
 (Use the controller to line up the 8 screw holes)

Chapter 2

2.1 Function Description

LSC Display

The LSC Display is a user friendly operator interface with 240 x 64 dots resolution; it allows the user to quickly view the system status and log.

Multiple Pumps Parallel Operation

The controller is able to control up to 4 VFD's and may be used for large volume booster pumping systems.

Lead/Lag Operation

A fully automatic lead/lag operation based on the variation of the system discharge flow allows you to significantly reduce your energy cost and consistently maintain the system piping pressure. While the lead pump is operating, the system will sequentially start and stop lag pump(s) based on variation of the system pressure.

Automatic Re-Start

Should the system shutdown by a sudden power loss, it will automatically restart when the power is restored. No manual reset is required. The system automatically returns to the running condition programmed and stored in the system memory.

Lead Pump Alternation

When selected as set time based, the alternation will occur when the total operating time of the lead pump reaches the alternation time; the system automatically selects the next pump in sequence to be the lead pump. This function is designed to reduce the system life cycle cost. The system makes all pumps operate for an equal period of time to prevent the over-use of a particular pump resulting in high parts wear of the pump. The alternation may also be cycle based rather than time based.

Faulty Pump(s) Skip Function

The system automatically detects faulty pump(s) and they will not be part of the operation sequence.

Dry Run Prevention

The system stops the running pump(s) upon detecting a low water level or low suction pressure signal. This prevents the pump(s) from dry running which may result in damage to the pump(s).

Operation Schedule

It is possible to program the set pressure based on a time/day/month basis.

Alarm Display and Logging

The system displays alarm conditions on the LCD monitor, and records the condition in a log that is date and timed stamped.

Operating Data Display and Storage

The semi-permanent operating data recording and storage for each pump allows efficient pump maintenance.

Freeze Prevention

The lead pump is automatically started (VFD minimum output) for 30 seconds and then shifted to the next pump when the temperature is under 32°F. This will occur when all pumps are stopped for more than 30 seconds at the same time.

Idle Prevention

If a lead pump does not run for a certain period of time, corrosion of some parts may occur. In order to prevent this, the system will automatically run the lead pump at the minimum operating speed for 60 seconds and then starts the next pump in sequence. The same process will be repeated if the succeeding lead pump does not run during the set time.

Password

If the password function is enabled, a User Password pop-up window will appear when you press the MENU button. You must enter your password to access the setup screens. This is to prevent access to the input values by any unauthorized person in advance. You can change or disable the user password if you wish. Each system has its own master password. Should you lose your password, call us to obtain a master password.

PID Control

This microprocessor-based controller is programmed to perform Proportional, Integral and Derivative control to provide consistent and reliable pressure control.

LCD Screen Saver

The back light of the LCD display is programmed to automatically fade out if the keypad is not used for a set time. This function allows for maximum life span of the LCD monitor.

Self-Diagnosis

The system includes a built-in self-diagnosis program that continuously monitors various system operating conditions.

Night Pump Operation

You can select Night-Pump (smaller pump) mode program to operate pumps with smaller capacity for night time. (Night pump is typically the smaller capacity pump).

2.2 Definitions

Menu Screen Items: Follow the menus on the main screen.

NOTE: A password may be required to access the Menu screens.

NO	Menu	Functions	Details
1	DATE TIME	Year/Month/Date/Week/Hour/Minute/Second Input	Set Year, Month, Date, Week, and Hour.
2	PUMP SET UP	Setting up the number of pumps to run in the sequence. Setting up the Night time pump.	Select a lead pump, the number of pumps to run. Select Night-pump mode.
3	PRESSURE SET UP	Adjust the set pressure & High/Low limit pressure/ Lag Run/Stop pressure setting.	Set the Set/High/Low/Lag Run/Stop pressure.
4	CONTROL SET UP	P/I/D value, Cycle Time, Shift, Friction, Run & Stop Delay, Operation Type, Low Water & Low Pressure Stop Time and Initialize.	Sets the control values.
5	SENSOR SET UP	Transducer Type/Sensor Adjusting Setting.	Select the used Pressure Sensor Range. Zero + Span + Offset adjustment.
6	VFD SET UP	VFD Stop Time, VFD Minimum Rate (speed), VFD Stop Time, VFD Output Display Type and VFD Auto Reset.	Set the type of Output Display for the VFD, stop time, minimum output, start rate and stop rate.
7	PROTECTION	Freeze prevention, Idle prevention and Password.	Automatically pump runs in case of pump stops for a set period of time with a temperature below 32°F for 2 minutes.
8	SYSTEM SET UP	Return to the Main Menu, LCD Back Light Time, Data Backup Interval, Test Code, Relay 1-4.	LCD screen return time, Back Light Display time, etc.
9	OPERATION SCHEDULE	Operation Schedule Mode selection (Time/Day/Month)	Operation Schedule (Time/Day/Month) setting.
10	COMMUNICATION SET UP	When using the communication feature.	Set Communication type, Set Speed, and Address Code.
11	ALARMS	Alarm data log.	Display the error information such as High/Low pressure limit alarm, water shortage alarm, VFD fault alarm. You can see the date and time when they occurred.
12	DATA LOG/ RUN TIMES	Data log for pump operation	Time & date stamps for run cycles and hour meter for each pump.

2.3 Default Values

Menus	Setup Menus	Default	Input Range
DATE TIME	YEAR	2000	0000 ~ 9999
	MONTH	1	1 ~ 12
	DATE	1	1 ~ 31
	WEEK	SUN	MONDAY ~ SUNDAY
	HOUR	0	0 ~ 23
	MINUTE	0	0 ~ 59
	SECOND	0	0 ~ 59
PUMP SET UP	LEAD PUMP	PUMP 1	1 ~ 4
	PUMP 1	USED	USED, NOT USED
	PUMP 2	USED	USED, NOT USED
	PUMP 3	NOT USED	USED, NOT USED
	PUMP 4	NOT USED	USED, NOT USED, NIGHT PUMP
	NIGHT TIME	00:00 ~ 04:00	00:00 ~ 23:59
PRESSURE SET UP	SET PRESSURE	60 PSI	2 PSI ~ 650 PSI
	HIGH PRESSURE LIMIT	95 PSI	3 PSI ~ 719 PSI
	LOW PRESSURE LIMIT	15 PSI	1 PSI ~ 649 PSI
	START LEAD PRESSURE	-3 PSI	-65 PSI ~ 65 PSI
	START LAG PRESSURE	-7 PSI	-65 PSI ~ 65 PSI
	STOP LAG PRESSURE	3 PSI	0 PSI ~ 65 PSI
CONTROL SET UP	P	60	0 ~ 200
	I	30	0 ~ 200
	D	1	0 ~ 200
	CYCLE TIME (PID)	120	50 ~ 999 M.SECS.
	ALTERNATION	24 HOURS	0 ~ 999 HOURS
	FRICTION	0.0 PSI	0 ~ 999 PSI
	RUN DELAY	0 SECONDS	0 ~ 10 SECONDS
	STOP DELAY	0 SECONDS	0 ~ 10 SECONDS
	OPERATION TYPE	VFD	VFD, MANUAL OPERATION
	LOW WATER STOP TIME	30 SECONDS	10 ~ 999 SECONDS
	LOW PRESSURE STOP TIME	30 SECONDS	10 ~ 999 SECONDS
	INITIALIZE		YES, NO
SENSOR SETUP	SENSOR VALUE	200 PSI	0 PSI ~ 720 PSI
	SENSOR OFFSET	0.0 PSI	-72 PSI ~ 72 PSI
VFD	VFD STOP TIME	30 SECONDS	0 ~ 60 SECONDS
	VFD MINIMUM RATE	50%	10 ~ 90
	VFD STOP RATE	60%	20 ~ 90
	VFD DISP. TYPE	100%	100%, 60Hz, 50Hz
	VFD AUTO RESET	5	0 ~ 20
PROTECTION	IDLE PREVENTION	NOT USED	USED, NOT USED
	FREEZE PREVENTION (OPTION)	NOT USED	USED, NOT USED
	PASSWORD USE	NOT USED	USED, NOT USED
	PASSWORD	1234	0000 ~ 9999

Menus	Setup Menus	Default	Input Range
SYSTEM SET UP	RETURN MAIN	120 SECONDS	10 ~ 300 SECONDS
	LCD BACK LIGHT TIME	600 SECONDS	10 ~ 999 SECONDS
	DATA BACKUP INTERVAL	120 SECONDS	10 ~ 999
	TEST CODE	0000	0 ~ 9999
	RELAY 1	PUMP 1 RUN	NOT USED, When the system stops, when the system operates, when the alarm is active. When the low water level alarm is active. Use as Buzzer.
	RELAY 2	PUMP 2 RUN	
	RELAY 3	PUMP 3 RUN	
	RELAY 4	ALARM	
	LANGUAGE	ENGLISH	ENGLISH, KOREAN
	PRESS UNIT	PSI	PSI, BAR
OPERATION SCHEDULE	SCHEDULE OPERATION	NOT USED	NOT USED, TIME, DAY, MONTH
	00:00:00 ~ 00:00:00	60 PSI	0.0 PSI ~ 900 PSI
	00:00:00 ~ 00:00:00	60 PSI	0.0 PSI ~ 900 PSI
	00:00:00 ~ 00:00:00	60 PSI	0.0 PSI ~ 900 PSI
	00:00:00 ~ 00:00:00	60 PSI	0.0 PSI ~ 900 PSI
	00:00:00 ~ 00:00:00	60 PSI	0.0 PSI ~ 900 PSI
	00:00:00 ~ 00:00:00		
	00:00:00 ~ 00:00:00		
	00:00:00 ~ 00:00:00		
	00:00:00 ~ 00:00:00		
	00:00:00 ~ 00:00:00		
	00:00:00 ~ 00:00:00		
	00:00:00 ~ 00:00:00		
	00:00:00 ~ 00:00:00		
	MONDAY:	60 PSI	0.0 PSI ~ 900 PSI
	TUESDAY:	60 PSI	0.0 PSI ~ 900 PSI
WEDNESDAY:	60 PSI	0.0 PSI ~ 900 PSI	
THURSDAY:	60 PSI	0.0 PSI ~ 900 PSI	
PROGRAM	JANUARY	60 PSI	0.0 PSI ~ 900 PSI
	FEBRUARY	60 PSI	0.0 PSI ~ 900 PSI
	MARCH	60 PSI	0.0 PSI ~ 900 PSI
	APRIL	60 PSI	0.0 PSI ~ 900 PSI
	MAY	60 PSI	0.0 PSI ~ 900 PSI
	JUNE	60 PSI	0.0 PSI ~ 900 PSI
	JULY	60 PSI	0.0 PSI ~ 900 PSI
	AUGUST	60 PSI	0.0 PSI ~ 900 PSI
	SEPTEMBER	60 PSI	0.0 PSI ~ 900 PSI
	OCTOBER	60 PSI	0.0 PSI ~ 900 PSI
	NOVEMBER	60 PSI	0.0 PSI ~ 900 PSI
	DECEMBER	60 PSI	0.0 PSI ~ 900 PSI
COMMUNICATION	RS232	NOT USED	NOT USED, MODEM, INTERNET
	COMMUNICATION SPEED (232)	9600 BPS	2400, 4800, 9600, 14400, 19200, 38400, 57600, 76800, 115200
	RS485	NOT USED	NOT USED, REMOTE
	COMMUNICATION SPEED (485)	9600 BPS	2400, 4800, 9600, 14400, 19200
	ADDRESS	0	0 ~ 31
	CODE.	0	0 ~ 999
ALARM DATA			Total 32 Data Save. (REFER TO 6.2)
OPERATION DATA			Total 2000 Data Save (REFER TO 6.3), Pump Run Times

2.4 Function Keys & Icon Description





2.4.1 Function Description

LCD Screen/LED Indicators/Keypad

- LCD:** Displays on the screen the operating status and setting.
- LED:** Displays the operation, alarm, operating pump, etc.
 - Four PUMP LED displays the operation of each pump.
 - LED Off: PUMP stopped
 - LED On: PUMP running
 - On & Off (flashing): VFD Faulted
 - The alarm LED will stop flashing when the fault is cleared.



3. Function Keys

-  Move to the setup screen from the main screen (Password Input Screen if password is enabled).
-  System Run/Stop
-  Return Screen/Input Cancel/Buzzer Stop, Alarm Cancel
-  Selection/Setting Data Save
-  Menu navigation and data entering

2.4.2 Description of Icon



“Pump Setting” - “Pump 1 ~ 4”
Set to “USED” when the pump is available for use.



“Pump Setting” - “Pump 4”
When you set “Night Pump”



“Pump Setting” - “Pump 1 ~ 4”
Set to “NOT USED” when the pump is NOT available for use.



The VFD faulted while operating the pump.

2.5 Description of LCD Screen

2.5.1 Opening Screen

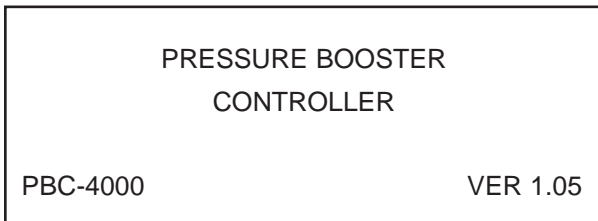

Opening Screen: when the controller power is turned on, the opening screen will be displayed for 3 seconds.

2.5.2 Main Screen

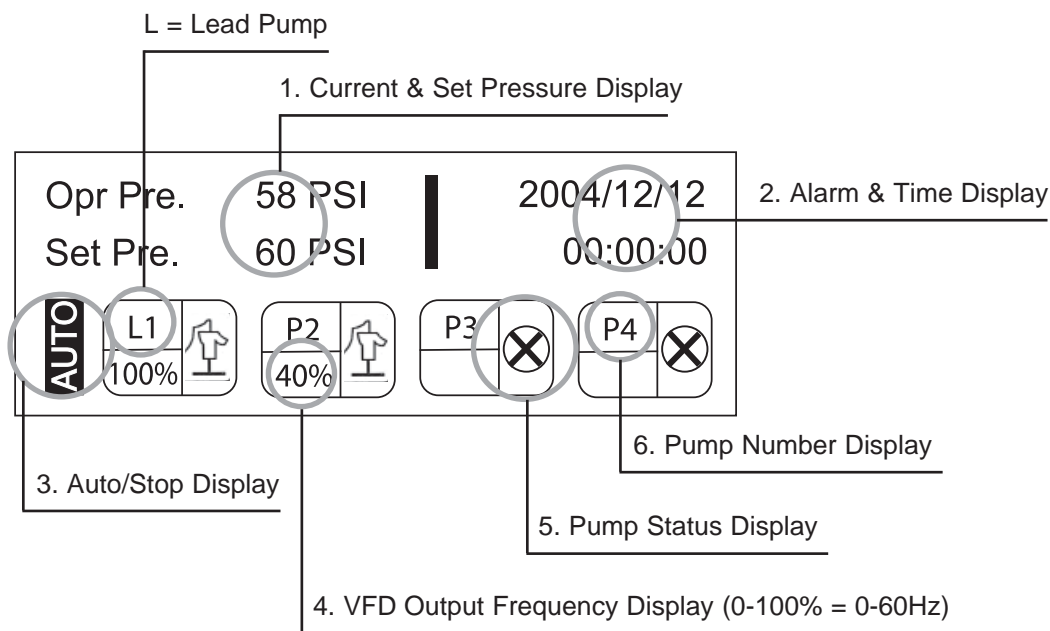

1. Current & Set Pressure Display: Display of the current and set pressure.
2. Alarm & Time Display: Display of the current time and alarm list if an alarm is active.
3. Auto/Stop Display: Display of the operating condition of the system.
“AUTO” - is displayed when the pumps are running or standby.
“STOP” - is displayed when the system is stopped.
4. VFD Output Frequency Display: Display of the output value of the VFD running.
The VFD output display can be configured in percentage (%) or in frequency (50Hz or 60Hz).
5. Pump Status Display: Idle, Running, VFD Fault, or Nighttime.
6. Pump Number: Display of the total pumps and Lead pump and numbers.
The Lead pump is labeled “L”, the other pumps are labeled “P”.

Chapter 3

3.1 Security

The security system is programmed to prevent access by unauthorized persons to control setup without User Password.

<PASSWORD INPUT>

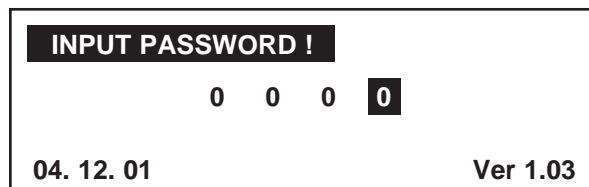

<Password Input Screen>

When you press the [MENU] button, the password pop-up window will appear as shown in the figure above. You must enter your user password “1234” to access the menu items screen.

- Set the password by using the Up/Down & Right/Left Key and press the Enter button.
- The password must consist of 4 numbers.
- The default User Password is 1234.

NOTE: After entering the password, access to the setup screen will be granted until the LCD backlight timer times out. The password will then need to be re-entered to access the setup screens. If you don't give any controls on the Setup Menu Screen, it will automatically return to the Main Screen. It is strongly recommended to change the password after the initial access. If you set the system control to factory default setting, the password is initialized to the default password “1234”. **NOTE: The password feature is disabled by default.**

3.2 Details of Setup Menus

3.2.1 Date/Time Setup: Current Time Setup

Menus	Setup Menu	Contents	Input Range
DATE/TIME	YEAR	Current Year Display	0000 ~ 9999
	MONTH	Current Month Display	1 ~ 12
	DATE	Current Date Display	1 ~ 31
	DAY	Current Day Display	MONDAY ~ SUNDAY
	HOUR	Current Hour Display	0 ~ 23
	MINUTE	Current Minute Display	0 ~ 59
	SECOND	Current Second Display	0 ~ 59

The time and date does not change should you set the set system to factory default.

3.2.2 Pump Setup: Used Pump, Night Time and Night Pump Setup

Menus	Setup Menu	Contents	Input Range
PUMP SETUP	LEAD PUMP	Lead Pump Setup	1 ~4
	PUMP 1	Pump Used or Not Used	Used, Not Used
	PUMP 2	Pump Used or Not Used	Used, Not Used
	PUMP 3	Pump Used or Not Used	Used, Not Used
	PUMP 4	Pump Used or Not Used	Used, Not Used, Night Pump
	NIGHT PUMP	Night operation time setup	00:00 ~ 23:59

3.2.3 Pressure Setup: Set Pressure (Target Pressure), High Pressure, Run Lead Pressure, Etc.

Menus	Setup Menu	Contents	Input Range
PRESSURE SETUP	SET PRESSURE	Run Pressure Setup	2 PSI ~ 650 PSI
	HIGH LIMIT ALARM	High Limit Alarm Occur Pressure	3 PSI ~ 719 PSI
	LOW LIMIT ALARM	Low Limit Alarm Occur Pressure	1 PSI ~ 649 PSI
	START LEAD PRESSURE (1)	Pressure deflection to run the Lead Pump at first	-65 PSI ~ 65 PSI
	START LAG PRESSURE (2)	Pressure deflection from set point to start lead	-65 PSI ~ 65 PSI
	STOP LAG PRESSURE (3)	Pressure deflection from set pressure to stop lag	0 PSI ~ 65 PSI

1. START LEAD

If the Set Pressure is 60.0 PSI and Start Lead Pressure -2.0 PSI, the lead pump will start when the operating pressure drops below 58.0 PSI.

2. START LAG PRESSURE

If the Set Pressure is 60.0 PSI and LAG start pressure is -5.0 PSI, the lag pump will start when the lead pump is operating as Maximum Output and the current pressure is below 55.0 PSI.

3. STOP LAG PRESSURE

If the Set Pressure is 60.0 PSI and the LAG stop pressure is 2.0 PSI, the lag pump will stop when the lag pump is operating as Minimum Speed and the current pressure is over 62.0 PSI.

3.2.4 Control Setup for the System Controls

Menus	Setup Menu	Contents	Input Range
CONTROL SETUP	P	P Value Setup of PID (Proportional)	0 ~ 200
	I	I Value Setup of PID (Integral)	0 ~ 200
	D	D Value Setup of PID (Derivative)	0 ~ 200
	CYCLE TIME	Cycle Time of PID Control	50 ~ 999 m.sec
	ALTERNATION	Alternate the Lead Pump to the next available pump, the accumulated run time equals this set value	0 ~ 999 HOURS Set 0 for cycle based alternation
	FRICTION	Friction loss in pumping system	0.0 PSI ~ 900 PSI
	RUN DELAY	Delay time for the lag pump to start	0 ~ 10 SECONDS
	STOP DELAY	Delay time for the lag pump to stop	0 ~ 10 SECONDS
	OPERATION TYPE	VFD	VFD, MANUAL OPERATION
	LOW WATER STOP TIME	Stop after the set time when the low water alarm occurred	10 ~ 999 SECONDS
	LOW PRESSURE STOP TIME	Stop after the set time when the low pressure alarm is maintained.	10 ~ 999 SECONDS
	INITIALIZE	All parameters are set to factory defaults (except data setup)	YES, NO

3.2.5 Sensor Setup: Sensor Range and Error Adjust Setup

Menus	Setup Menu	Contents	Input Range
SENSOR SETUP	TRANSDUCER TYPE	Enter the span of the transducer	0 PSI ~ 720 PSI*
	SENSOR ADJUST	Enter the offset of the transducer	-72 PSI ~ 72 PSI

*NOTE: You will not be able to set a value less than the "HIGH LIMIT ALARM in the "PRESSURE SETUP" menu.

3.2.6 Inverter Setup: Setup for the VFD

Menus	Setup Menu	Contents	Input Range
VFD	VFD STOP TIME (1)	Time Setup when the last pump stops	0 ~ 60 SECONDS
	VFD MINIMUM RATE	VFD Minimum Output (speed)	10 ~ 90
	VFD STOP RATE (1)	The last pump stops when it outputs under set value	20 ~ 90
	VFD DISP. TYPE	Display the VFD Output Value on the main screen	100%, 60Hz, 50Hz
	VFD AUTO RESET	Reset times after an alarm happened while the VFD was operating	0 ~ 20

1. The last pump will stop after the stop time has elapsed with the pump running below the stop rate.

3.2.7 Protection: Functions for the System Protect

Menus	Setup Menu	Contents	Input Range
PROTECT	FIX PREVENTION (2)	Operate for the pump fix prevention	USED, NOT USED
	FREEZE PREVENTION (3)	Operate for the pump freeze prevention	USED, NOT USED
	PASSWORD	Password change	0000 ~ 9999

2. If you set the fix prevention to "USED" and the pump does not operate for 10 days, it will operate at the minimum output rate for 30 seconds. After the operation, it will change the lead pump.

3. If you set the freeze prevention to "USED" and enter the freeze operation signal, it will operate at the minimum output rate for 30 seconds. After operation, it will change the lead pump (option).

3.2.8 System Setup

Menus	Setup Menu	Contents	Input Range
SYSTEM SETUP	RETURN MAIN SCREEN	Return to the main screen after set time if user does not use any key controls	10 ~ 300
	LCD BACK LIGHT TIME	After the set time, LCD BACK LIGHT automatically turns off	10 ~ 300
	DATA BACKUP INTERVAL	Set the sampling rate for the operation data log	10 ~ 999
	TEST CODE	The code to check the system. It is able to occur to the wrong operation, if you set any data	0 ~ 9999
	RELAY 1	Programmable	Not Used, System Stop, System Run, Alarm, Low Water, Pump 1-4 Run and Buzzer
	RELAY 2	Programmable	
	RELAY 3	Programmable	
	RELAY 4	Programmable	
	LANGUAGE	Set the controller language	English/Korean
	PRESS UNIT	Set the pressure units	PSI/BAR

3.2.9 Communication Setup: Communication for External Interface

Menus	Setup Menu	Contents	Input Range
COMMUNICATION SETUP	RS232	Type select	Not Used, MODEM, INTERNET
	BAUDRATE (232)	Set the communication speed (RS232)	2400, 4800, 9600, 14400, 19200, 38400, 57600, 76800, 115200
	RS485	Select	Not Used, REMOTE
	BAUDRATE (485)	Set the communication speed (RS485)	2400, 4800, 9600, 14400, 19200
	SLAVE ADDRESS	Slave Address when you set the remote of RS485	0 ~ 31
	CODE	Characteristic numbers and communication code when RS232 control	0 ~ 999

3.3 Setup Menu Display & Input Method

Example for the Data Setup Change

DATE/TIME	PUMP SET	PRESSURE
CONTROL	SENSOR	VFD
PROTECT	SYSTEM	PROGRAM
COMM SET	ALARMS	DATA LOG

<Fig 1> Menu Setup Screen

DATE & TIME SETUP (4.0/RUN)
2005 / 12 / 22 [WED]
11 : 00 : 00

<Fig 2> Data Setup Change Screen

DATE & TIME SETUP (4.0/RUN)
2005 / 12 / 22 [WED]
11 : 00 : 00

<Fig 3> Date Setup Change Screen

1. The display will change to <Fig 2> if you press the enter button after selecting the Date/Time on the Menu Setup <Fig 1>.
2. Moved to the set position which needs to be changed: Year/Month/Day/Week by Right & Left key. Press the Enter key and edit when flashing.
3. Change the value by using the Up/Down keys.
4. Save the changed value by pressing the Enter key.
5. Exit to the main screen by pressing the Cancel key.

Example for the Pressure Setup Change

Opr Pre.	58 PSI	2004/12/12
Set Pre.	60 PSI	00:00:00
AUTO	L1 100%	P2 40%
		P3 P4

<Fig 1> Main Screen

DATE/TIME	PUMP SET	PRESSURE
CONTROL	SENSOR	VFD
PROTECT	SYSTEM	PROGRAM
COMM SET	ALARMS	DATA LOG

<Fig 2> Menu Setup Screen

DATE/TIME	PUMP SET	PRESSURE
CONTROL	SENSOR	VFD
PROTECT	SYSTEM	PROGRAM
COMM SET	ALARMS	DATA LOG

<Fig 3> Pressure Setup Change Screen

PRESSURE SETUP	(60.0/RUN)
SET PRESSURE	60 PSI
HIGH PRE. LIMIT	150 PSI
LOW PRE. LIMIT	20 PSI

<Fig 4> Pressure Setup Change Screen

PRESSURE SETUP	(60.0/RUN)
SET PRESSURE	6 PSI
HIGH PRE. LIMIT	150 PSI
LOW PRE. LIMIT	20 PSI

<Fig 5> Pressure Setup Change Screen

PRESSURE SETUP	(60.0/RUN)
SET PRESSURE	6 PSI
HIGH PRE. LIMIT	150 PSI
LOW PRE. LIMIT	20 PSI

<Fig 6> Pressure Setup Change Screen

Press the "MENU" button.

Use the UP/DOWN and RIGHT/LEFT keys to go to the Pressure Menu.

Press "ENTER" button to open the Pressure Menu.

Moved to the set position which needs to be changed using the UP/DOWN key. Press "ENTER" key.

Use the UP/DOWN and RIGHT/LEFT keys to edit.

Save the changed value by pressing the Enter key. Exit to the main screen by pressing the Cancel key.

Chapter 4

4.1 Typical Triplex VFD Power Schematic

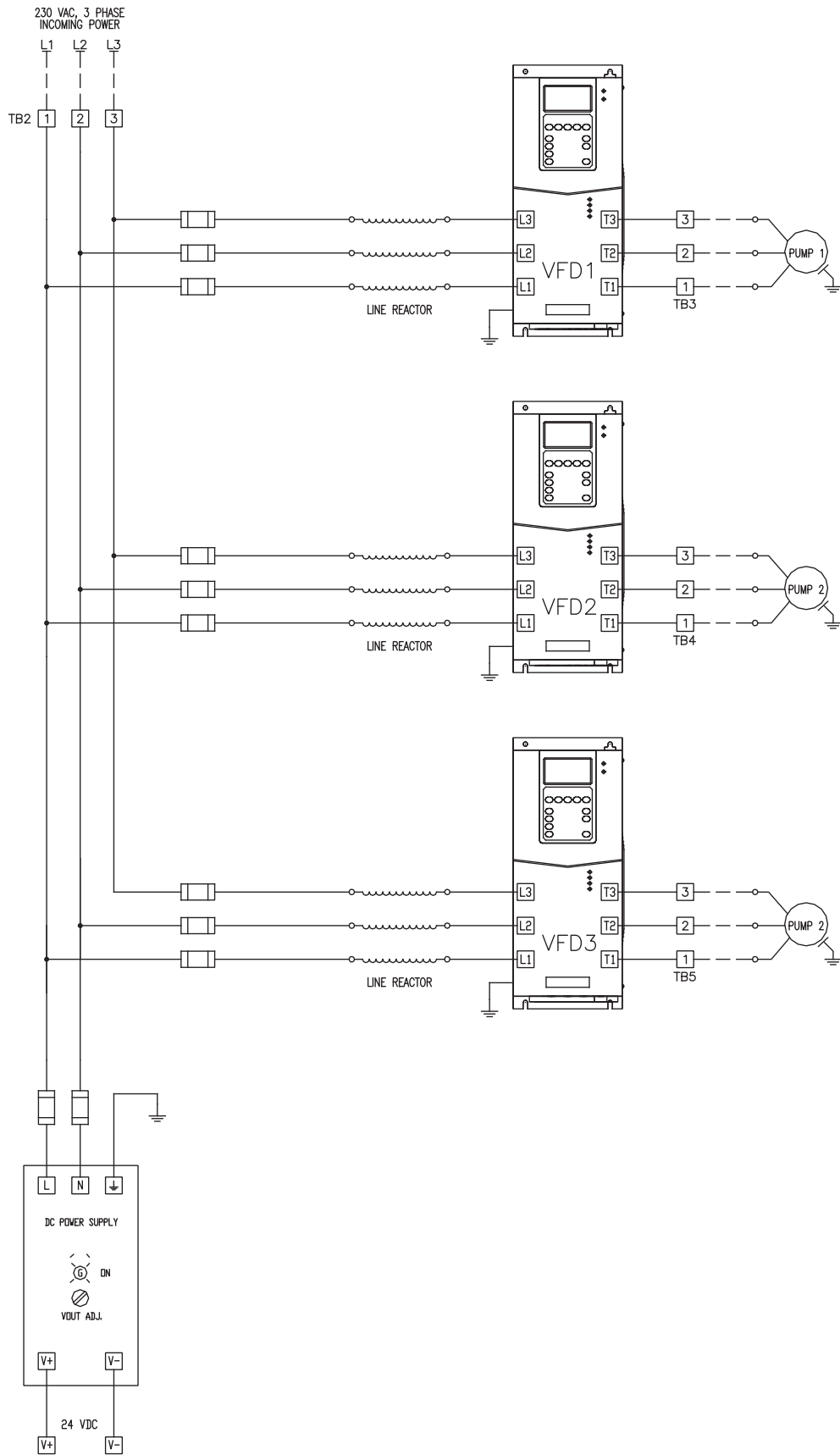

4.2 Typical Triplex Controller Circuit Schematic

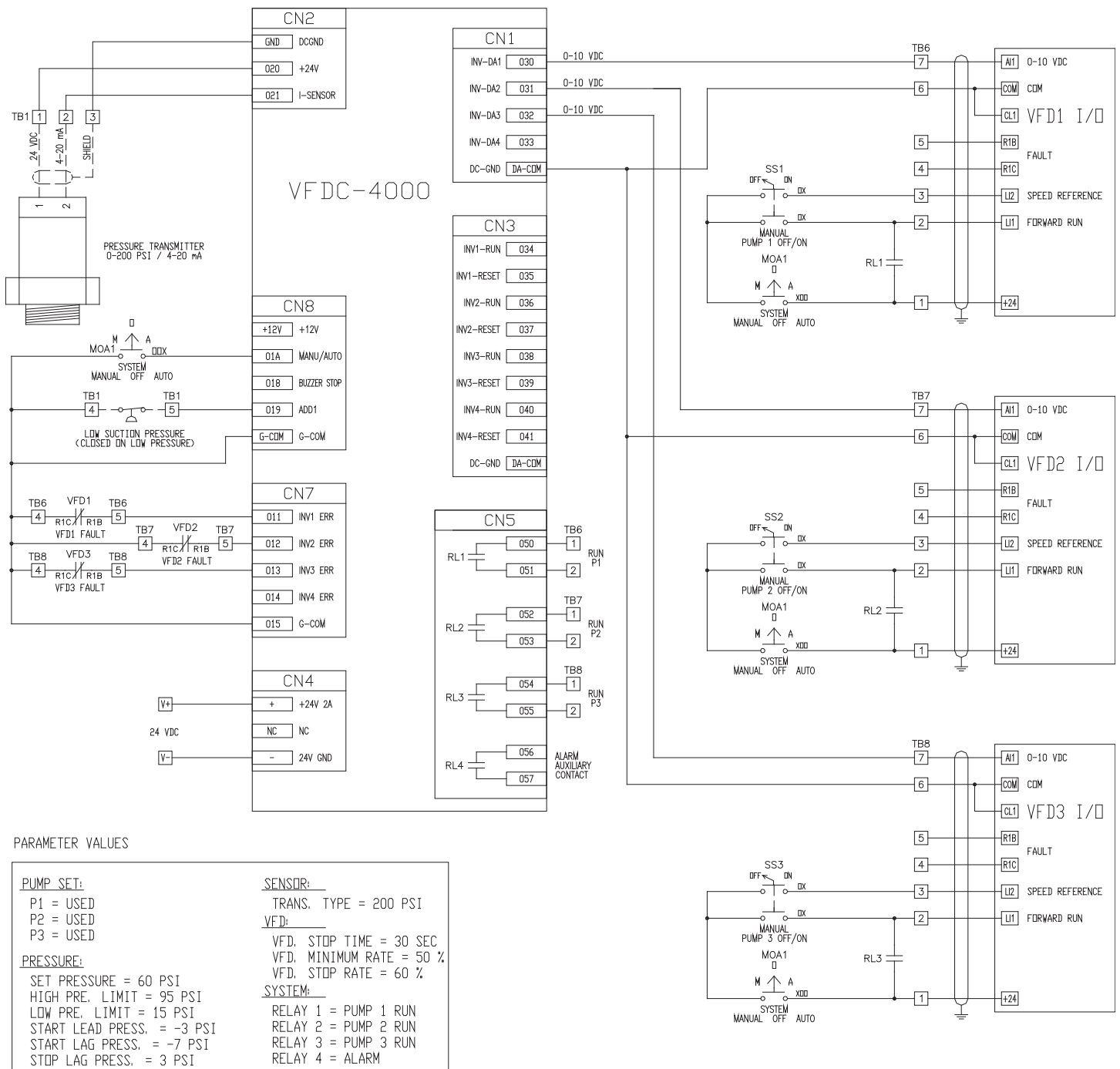

Chapter 5





5.1 Troubleshooting

Troubles	Major Cause	Actions
The operating pressure does not increase after pump starts.	Pump air locked	Consult your mechanical contractor
	Check valve back flow defective	Consult your mechanical contractor
	Insufficient pump capacity	Consult your mechanical contractor
	Bad connection to the pressure transducer	Consult your mechanical contractor
	The infiltration of foreign object into the pump	Consult your mechanical contractor
	Broken coupling	Consult your mechanical contractor
	Pump reverse rotation	Consult your mechanical contractor
	The discharge valve closed	Consult your mechanical contractor
	Air infiltration into the discharge pipe	Consult your mechanical contractor
	Discharge pipe crack (low pressure alarm condition)	Consult your mechanical contractor
	Damage on the pressure transducer	Replace the pressure transducer
Pump does not stop.	Incorrect VFD stop rate	Increase VFD stop rate
	Bad connection to the pressure transducer	Connect the pressure transducer hose
	Defective pressure transducer	Compare pressure gauge to transducer, replace if necessary
Pump repeats start and stop too frequently.	Check valve back flow	Consult your mechanical contractor
	Abnormal air pressure tank	Consult your mechanical contractor
	Insufficient pressure tank capacity	Consult your mechanical contractor
Over current and trip while pump runs.	Abnormal voltage	Check the voltage
	Defective motor	Consult your mechanical contractor
	The pump is broken	Consult your mechanical contractor
	The infiltration of foreign object into the pump	Consult your mechanical contractor
Pump does not start after turning on the power.	Circuit breaker off	Turn on the circuit breaker
	No water in the reservoir	Fill the reservoir with water
	The motor is out of order	Repair the motor or replace it
	Abnormal voltage	Check the voltage
	VFD tripped	Reset VFD
	The pressure transducer is out of order	Repair the pressure transducer or replace it
	Bad motor wiring	Check the motor wiring and correct it if required
Pump running out of sequence.	Bad panel control cable connection	Correct the cable connection
LCD display is not viewable.	Excessive noise	Turn off the power and turn on, or reset
	LCD defective	Replace LCD

Chapter 6

6.1 Fault Alarm Display & Corrective Action

6.1.1 High Pressure Alarm

Opr Pre.	150 PSI		HIGH PRESS	
Set Pre.	60 PSI		00:00:00	
AUTO	L1 100% 	P2 40% 	P3 	P4 





Cause: The current pressure was higher than the High Limit Pressure while the system was operating.

Reset: Auto reset clear. The current pressure was less than the High Limit Pressure and the system has stopped.

Output: LCD Display/ERROR LED/BUZZER

Actions: Please check the pipe and system.

6.1.2 Low Pressure Alarm

Opr Pre.	0 PSI		LOW PRESS	
Set Pre.	60 PSI		00:00:00	
AUTO	L1 100% 	P2 40% 	P3 	P4 





Cause: The current pressure was less than the Low Limit Pressure while the system was operating.

Reset: The current pressure was higher than the Low Limit Pressure and the system has stopped.

Output: LCD Display/ERROR LED/BUZZER

Actions: Please check the pipe and system. The system will stop if the alarm is active for longer than the set time (refer to 3.2.4). Press Cancel to reset and Run/Stop to run the system again.

6.1.3 Low Water Level Alarm

Opr Pre.	0 PSI		LOW WATER	
Set Pre.	60 PSI		00:00:00	
AUTO	L1 100% 	P2 40% 	P3 	P4 





Cause: Low water level signal was present while the system was operating.

Reset: The Cancel key must be pressed and selection switch must be off.

Output: LCD Display/ERROR LED/BUZZER

Actions: Please check the pipe, low water level wiring and change the low water level sensor. The system will stop if the alarm is active for longer than the set time (refer to 3.2.4). Press Cancel to reset and Run/Stop to run the system again.

6.1.4 Sensor Fail/Open Circuit

Opr Pre.	0 PSI		SENS OPEN	
Set Pre.	60 PSI		00:00:00	
AUTO	L1 100% 	P2 40% 	P3 	P4 





Cause: The pressure sensor has failed, shorted, or opened.

Reset: The sensor is normally operating.

Output: LCD Display/ERROR LED/BUZZER

Actions: Please check the connection to the pressure sensor and replace if necessary. Press Run/Stop to run the system after the sensor is replaced.

6.1.5 VFD Error

Opr Pre.	58 PSI		VFD ERROR	
Set Pre.	60 PSI		00:00:00	
AUTO	L1 100% 	P2 40% 	P3 	P4 





Cause: The VFD Error Signal was present while the system was operating.

Reset: Error signal was cleared after VFD reset and the system has stopped.

Output: LCD Display/ERROR LED/BUZZER





Actions: Please check the wiring and VFD parameter. Repair the inverter or replace it.

6.1.6 Low Pressure Stop

Opr Pre.	58 PSI		LOW PRE ST
Set Pre.	60 PSI		00:00:00
STOP	L1 	P2 	P3 
	0%	0%	P4 

Cause: The low pressure alarm was active for longer than the set time (refer to 3.2.4).
Reset: Press the Cancel key on the main screen.
 Press RUN to restart
Output: LCD Display/ERROR LED/BUZZER
Actions: Please check the pipe and system.

6.1.7 Low Water Level Stop

Opr Pre.	58 PSI		LOW PRE ST
Set Pre.	60 PSI		00:00:00
STOP	L1 	P2 	P3 
	0%	0%	P4 

Cause: The alarm was active for longer than the set time (refer to 3.2.4).
Reset: Press the Cancel key to clear the low water level pressure. Press RUN to restart the system.
Output: LCD Display/ERROR LED/BUZZER
Actions: Please check the pipe and system. When the low water alarm level is cleared, the pump auto restarts after 60 seconds.

6.2 Alarm Data Screen

Alarm Data Screen View/Acknowledgement Method

The system is able to record total 32 data. Records and displays the alarm sequentially by Number, Date, Alarm Occur times and alarm type.

ALARM DATA		(0.0/RUN)
1.	04/12/15 14:16	4 SENS OPEN
2.	04/12/15 14:16	2 LOW PRESS
3.	04/12/15 14:16	1 LOW WAT ST ▼

UP/DOWN KEY: Scroll the list each 1 line.

6.3 Operation Data Log Screens and Run Times

To access the Operation Data (Data Log) or the Run Times, go to the Menu Setup screen.

DATE/TIME	PUMP SET	PRESSURE
CONTROL	SENSOR	VFD
PROTECT	SYSTEM	PROGRAM
COMM SET	ALARMS	DATA LOG

Use the UP/DOWN and RIGHT/LEFT keys to go to the Data Log Menu.

Menu Setup Screen

DATE/TIME	PUMP SET	PRESSURE
CONTROL	SENSOR	VFD
PROTECT	SYSTEM	PROGRAM
COMM SET	ALARMS	DATA LOG

Press "ENTER" button to open the Data Log Menu.

Use the ▲ or ▼ keys to select between OPERA DATA ▲▼ RUN TIME
 "Enter" to display.

6.3.1 Operation Data Log Screen

It is able to record total 2000 data. Records and displays in the following format: Month/Date, Hour: Minute: Second, Current Pressure, Lead Pump, Current Output and Condition.

OPERA DATA		(0.0/RUN)		
12/24	13:24:08	4.0	1P	78%
12/24	13:29:39	4.0	1P	77%
12/24	13:32:39	4.0	1P	78%
12/24	13:43:39	4.0	1P	78%
12/24	13:42:21	0.0	1P	48%LoP
12/24	13:55:21	0.0	1P	40%RUN

UP/DOWN KEY: Scroll the list each 1 line. RIGHT/LEFT KEY: Scroll the list each 60 lines.

6.3.2 Records List

Records regularly while operating. Set the system when the system is operating.

Records regularly based on the Operation Data Interval set value.

"12/23 14:43:33 0.0 1P 0%"

Records when an alarm occurred.

"12/26 14:43:33 0.0 1P 0%Hip" High Pressure Alarm

"12/23 14:43:33 0.0 1P 0%LoP" Low Pressure Alarm

"12/23 14:43:33 0.0 1P 0%LoW" Low Water Alarm

"12/23 14:43:33 0.0 1P 0%I1E" VFD 1 Error

"12/23 14:43:33 0.0 1P 0%I2E" VFD 2 Error

"12/23 14:43:33 0.0 1P 0%I3E" VFD 3 Error

"12/23 14:43:33 0.0 1P 0%I4E" VFD 4 Error

"12/23 14:43:33 0.0 1P 0%LPS" Low Pressure Stop

"12/23 14:43:33 0.0 1P 0%Sop" Sensor Open

"12/23 14:43:33 0.0 1P 0%Sap" Sensor Shortage

"12/23 14:43:33 0.0 1P 0%LWS" Low Water StopRecords when power is supplied.

Displays as "12/23 14:43:33 0.0 1P 0%Pun"

Records when the system operation starts.

Displays as "12/23 14:43:33 0.0 1P 0%RUN"

Records when the system operation stops.

Displays as "12/23 14:43:33 0.0 1P 0%STP"

1. RUN TIMES

OPERA DATA	(0.0/RUN)	
P1:	10 HOURS	42 MINS
P2:	10 HOURS	47 MINS
P3:	2 HOURS	41 MINS
P4:	0 HOURS	0 MINS

A record of each pump run time is logged on this screen.

ModBus Communication Functions & Address Code

Functions	Description	Address (Hex)	Scaling
SYSTEM ON	System Run	AD 10 70 0D 00 01 00 01 CH CL	
SYSTEM OFF	System Off	AD 10 70 0D 00 01 00 01 CH CL	
PRESSURE SETUP	1: Set Pressure	AD 10 82 01 00 01 00 SP CH CL	
	2: Over Pressure	AD 10 82 02 00 01 00 SP CH CL	
	3: Low Pressure	AD 10 82 03 00 01 00 SP CH CL	
	4: Run Pressure	AD 10 82 04 00 01 00 SP CH CL	
	5: Sub Run Pressure	AD 10 82 05 00 01 00 SP CH CL	
	6: Sub Stop Pressure	AD 10 82 06 00 01 00 SP CH CL	
LOW WATER	Low Water Error	AD 03 70 02 00 01 CH CL	0x80: low water, 0x00: no error
PUMP RUN SETUP	VFD1 Run Setup		0x01: VFD1 run setup
	VFD2 Run Setup	AD 03 70 0A 00 01 CH CL	0x02: VFD2 run setup
	VFD3 Run Setup		0x04: VFD3 run setup
	VFD4 Run Setup		0x08 VFD4 run setup
CURRENT PRESSURE	Current Pressure	AD 03 70 0B 00 01 CH CL	Current Pressure x 10
SET PRESSURE	Set Pressure	AD 03 70 0C 00 01 CH CL	Set Pressure x 10
RUN STATE	Run State	AD 03 70 0D 00 01 CH CL	0x41: start, 0x40: stop
ERROR FLAG	Error Flag	AD 03 70 0E 00 01 CH CL	0x001: high pressure
			0x002: low pressure
			0x004: VFD1 fault
			0x008: VFD2 fault
			0x010: VFD3 fault
			0x020: VFD4 fault
			0x040: low water alarm
			0x080: low pressure alarm
			0x090: sensor open
			0x100: sensor short
0x200: low water stop			
TIME SETUP	1: year	AD 03 80 01 ~ 7 00 01 CH CL	2xxxx
	2: month		xx
	3: day		xx
	4: hour		xx
	5: min		xx
	6: sec		xx
VFD SETUP	1: main pump	AD 03 81 01 ~ 5 00 01 CH CL	1 ~ 4
	2: pump 1		0: not used, 1: used
	3: pump 2		0: not used, 2: used
	4: pump 3		0: not used, 3: used
	5: pump 4		0: not used, 4: used
PRESSURE SETUP	1: set pressure	AD 03 82 01 ~ 6 00 01 CH CL	set pressure x 10
	2: over pressure		over pressure x 10
	3: low pressure		low pressure x 10
	4: run pressure		run pressure x 10
	5: sub run pressure		sub run pressure x 10
	6: sub stop pressure		sub stop pressure x 10

ModBus Communication Functions & Address Code

Functions	Description	Address (Hex)	Scaling
SYSTEM ON	System Run	AD 10 70 0D 00 01 00 01 CH CL	
SYSTEM OFF	System Off	AD 10 70 0D 00 01 00 01 CH CL	
PRESSURE SETUP	1: Set Pressure	AD 10 82 01 00 01 00 SP CH CL	
	2: Over Pressure	AD 10 82 02 00 01 00 SP CH CL	
	3: Low Pressure	AD 10 82 03 00 01 00 SP CH CL	
	4: Run Pressure	AD 10 82 04 00 01 00 SP CH CL	
	5: Sub Run Pressure	AD 10 82 05 00 01 00 SP CH CL	
	6: Sub Stop Pressure	AD 10 82 06 00 01 00 SP CH CL	
LOW WATER	Low Water Error	AD 03 70 02 00 01 CH CL	0x80: low water, 0x00: no error
PUMP RUN SETUP	VFD1 Run Setup		0x01: VFD1 run setup
	VFD2 Run Setup	AD 03 70 0A 00 01 CH CL	0x02: VFD2 run setup
	VFD3 Run Setup		0x04: VFD3 run setup
	VFD4 Run Setup		0x08 VFD4 run setup
CURRENT PRESSURE	Current Pressure	AD 03 70 0B 00 01 CH CL	Current Pressure x 10
SET PRESSURE	Set Pressure	AD 03 70 0C 00 01 CH CL	Set Pressure x 10
RUN STATE	Run State	AD 03 70 0D 00 01 CH CL	0x41: start, 0x40: stop
ERROR FLAG	Error Flag	AD 03 70 0E 00 01 CH CL	0x001: high pressure
			0x002: low pressure
			0x004: VFD1 fault
			0x008: VFD2 fault
			0x010: VFD3 fault
			0x020: VFD4 fault
			0x040: low water alarm
			0x080: low pressure alarm
			0x090: sensor open
			0x100: sensor short
0x200: low water stop			
TIME SETUP	1: year	AD 03 80 01 ~ 7 00 01 CH CL	2xxxx
	2: month		xx
	3: day		xx
	4: hour		xx
	5: min		xx
	6: sec		xx
VFD SETUP	1: main pump	AD 03 81 01 ~ 5 00 01 CH CL	1 ~ 4
	2: pump 1		0: not used, 1: used
	3: pump 2		0: not used, 2: used
	4: pump 3		0: not used, 3: used
	5: pump 4		0: not used, 4: used
PRESSURE SETUP	1: set pressure	AD 03 82 01 ~ 6 00 01 CH CL	set pressure x 10
	2: over pressure		over pressure x 10
	3: low pressure		low pressure x 10
	4: run pressure		run pressure x 10
	5: sub run pressure		sub run pressure x 10
	6: sub stop pressure		sub stop pressure x 10

Functions	Description	Address (Hex)	Scaling
CONTROL SETUP	1: pvalue	AD 03 83 01 00 01 CH CL	pvalue x 10
	2: ivalue	AD 03 83 02 00 01 CH CL	ivalue x 10
	3: dvalue	AD 03 83 03 00 01 CH CL	dvalue x 10
	4: cycle time	AD 03 83 04 00 01 CH CL	cycle time
	5: shift	AD 03 83 05 00 01 CH CL	shift
	6: friction	AD 03 83 06 00 01 CH CL	friction x 10
	7: run delay	AD 03 83 07 00 01 CH CL	sec
	8: stop delay	AD 03 83 08 00 01 CH CL	sec
	9: oper type	AD 03 83 09 00 01 CH CL	x
	10: low water stop time	AD 03 83 0A 00 01 CH CL	sec
	11: low pressure stop time	AD 03 83 0B 00 01 CH CL	sec
SENSOR SETUP	1: trans type	AD 03 84 01 00 01 CH CL	trans type x 10
	2: sensor adjust	AD 03 84 02 00 01 CH CL	sensor adjust x 10
VFD SETUP	1: VFD stop time	AD 03 85 01 00 01 CH CL	%
	2: VFD minimum rate	AD 03 85 02 00 01 CH CL	%
	3: VFD stop rate	AD 03 85 03 00 01 CH CL	%
	4: VFD out value type	AD 03 85 04 00 01 CH CL	%
	5: VFD auto reset	AD 03 85 05 00 01 CH CL	%
PREVENTION SETUP	1: freeze prevention	AD 03 86 01 00 01 CH CL	0: no, 1: yes
	2: fix prevention	AD 03 86 02 00 01 CH CL	0: no, 1: yes
	3: password	AD 03 86 03 00 01 CH CL	1234 or 1004
ERROR COUNT	high pressure alarm count	AD 03 90 02 00 01 CH CL	no
	low pressure alarm count	AD 03 90 04 00 01 CH CL	no
	low water alarm count	AD 03 90 06 00 01 CH CL	no
	VFD1 alarm count	AD 03 90 08 00 01 CH CL	no
	VFD2 alarm count	AD 03 90 0A 00 01 CH CL	no
	VFD3 alarm count	AD 03 90 0C 00 01 CH CL	no
	VFD4 alarm count	AD 03 90 0E 00 01 CH CL	no
	VFD1-4 all alarm count	AD 03 90 10 00 01 CH CL	no

AD = ADDRESS

SP = Set Pressure x 10 (->Hex value change)

CH = CRC HIGH

CL = CRC LOW

Serial Cable for RS232 Communications with the VFDC-4000

9 PIN Male (PC)

9 PIN Male (VFDC-4000)

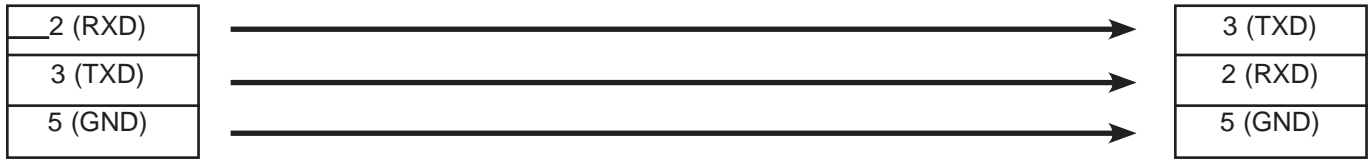

ONE-YEAR LIMITED WARRANTY

SJE-RHOMBUS® warrants to the original consumer that this product shall be free of manufacturing defects for one year after the date of manufacture. During that time period and subject to the conditions set forth below, SJE-RHOMBUS will repair or replace, for the original consumer, any component which proves to be defective due to defective materials or workmanship of SJE-RHOMBUS.

ELECTRICAL WIRING AND SERVICING OF THIS PRODUCT MUST BE PERFORMED BY A LICENSED ELECTRICIAN.

THIS WARRANTY DOES NOT APPLY: (A) to damage due to lightning or conditions beyond the control of SJE-RHOMBUS; (B) to defects or malfunctions resulting from failure to properly install, operate or maintain the unit; (C) to failures resulting from abuse, misuse, accident, or negligence; (D) to units which are not installed in accordance with applicable local codes, ordinances, or accepted trade practices, and (E) to units repaired and/or modified without prior authorization from SJE-RHOMBUS.

Some states do not allow limitations on how long an implied warranty lasts, so the above limitation may not apply to you. Some states do not allow the exclusion or limitation of incidental or consequential damages, so the above limitation or exclusion may not apply to you. This warranty gives you specific legal rights, and you may also have other rights which vary from state to state.

TO OBTAIN WARRANTY SERVICE: The consumer shall assume all responsibility and expense for removal, reinstallation and freight of controller deemed defective. Any controller to be repaired or replaced under this warranty must be returned to SJE-RHOMBUS, or such place as designated by SJE-RHOMBUS.

ANY IMPLIED WARRANTIES OF MERCHANTABILITY OR FITNESS ARE LIMITED TO THE DURATION OF THIS WRITTEN WARRANTY. SJE-RHOMBUS SHALL NOT, IN ANY MANNER, BE LIABLE FOR ANY INCIDENTAL OR CONSEQUENTIAL DAMAGES AS A RESULT OF A BREACH OF THIS WRITTEN WARRANTY OR ANY IMPLIED WARRANTY.

Warranty void if back cover of this product is removed. Call factory with servicing questions: **1-800-RHOMBUS** (1-800-746-6287).



22650 County Hwy. 6 ■ PO Box 1708 ■ Detroit Lakes, MN 56502 USA
1-888-DIAL-SJE (1-888-342-5753) ■ 218-847-1317 ■ Fax 218-847-4617
www.sjerrhombus.com

The logo features the word "SJE" in a bold, italicized, red sans-serif font. A dark blue circle with a white dot inside is positioned behind the letter "E". Below "SJE" is the word "Rhombus" in a larger, bold, italicized, red sans-serif font. A registered trademark symbol (®) is located at the end of the word.

SJE
Rhombus®

22650 County Highway 6, PO Box 1708

Detroit Lakes, MN 56502 USA

1-888-DIAL-SJE (1-888-342-5753)

Phone: 218-847-1317

Fax: 218-847-4617

www.sjerrhombus.com

©SJE-Rhombus 04/09 1024181A